

L18 Laser Line 18mm Plastic Housing
20m* Range Polarized Retro Reflective



L18 (20m)* range 18mm housing
Polarized Retro Reflective

Laser emission with teach in

Great for use general harsh duty applications

4 wire 10-30VDC

LED's for set up & diagnostics

M12 connector & cable available

Laser Line Series
IP67 protection degree plastic housing

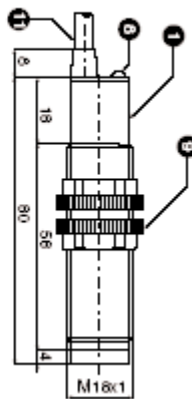
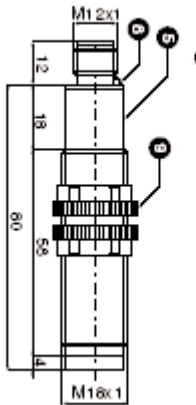

- 1. - standard cable exit M1
- 5. - M12 connector K2
- 8. - LED indicators
- 9. - nut/hexagon nut
- 11. - cable 4(2)X0.34mm,4.7mm diameter, PVC, 2m

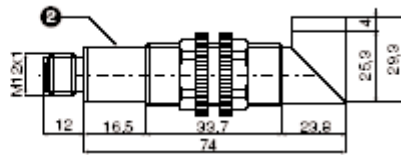
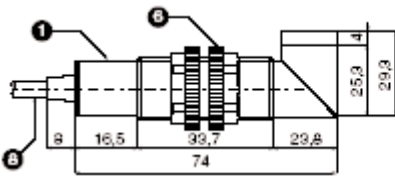

- 1. - standard cable exit M1
- 2. - M12 connector K2
- 6. - nut/hexagon nut
- 8. - cable 4(2)X0.34mm,4.7mm diameter, PVC,

Parts Matrix

photo electric sensor series	P	P
laser-polarized retro reflective	PL	PL
20m max range (w/OX110) 30m (w/OX201)*	020*	020*
18mm diameter	9	9
PBT plastic housing	P	P
PNP	P	
NPN		N
light opearted/dark operated	8	8
q/qnot programming*	7	7
90 degree optics (radial)	R	
straight optics (axial)		T
2m standard integrated cable	M1	M1
K2 4 Pin 12mm connector	K2	K2

PARTS INDEX

- PPL0209PP8RM1
- PPL0209PN8RM1
- PPL0209PP8RK2
- PPL0209PN8RK2
- PPL0209PP7RK2
- PPL0209PN7RK2
- PPL0209PP8TM1
- PPL0209PN8TM1
- PPL0209PP8TK2
- PPL0209PN8TK2
- PPL0209PP7TK2
- PPL0209PN7TK2

SPECIFICATIONS

- PNP L/D 90 DEGREE M1
- NPN L/D 90 DEGREE M1
- PNP Q/QN 90 DEGREE K2
- NPN Q/QN 90 DEGREE K2
- PNP L/D 90 DEGREE K2
- NPN L/D 90 DEGREE K2
- PNP L/D M1
- NPN L/D M1
- PNP Q/QN K2
- NPN Q/QN K2
- PNP L/D K2
- NPN L/D K2

Complementary outputs

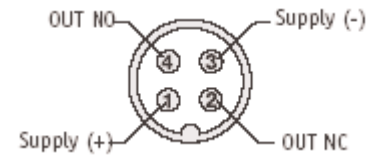
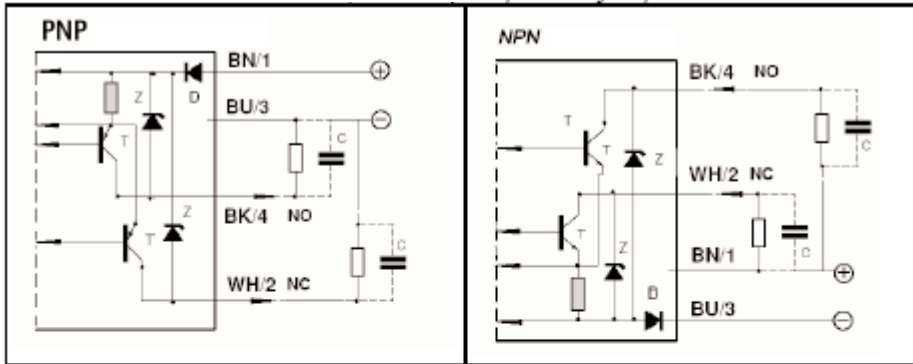

Lon-Don selectable outputs

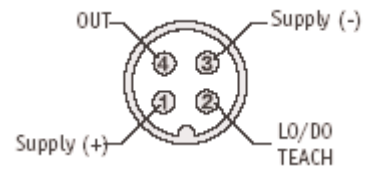
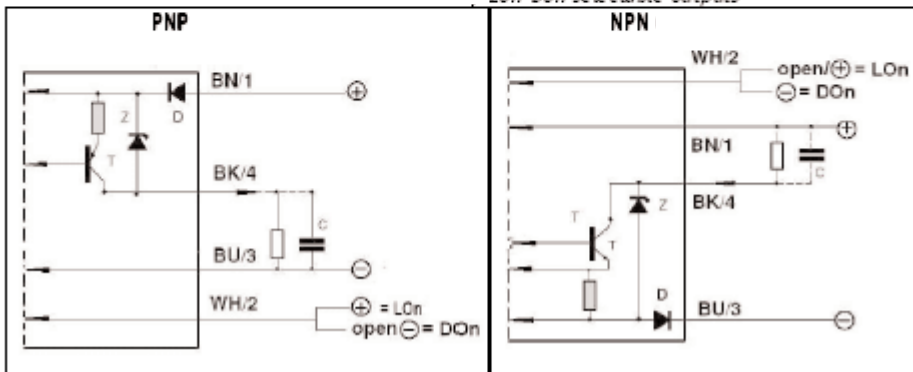

Nominal Sensing Distance S_n	20m
Emission	Red laser diode 650nm/class 1 laser (IEC60825-1)
Repeat accuracy	5%
Differential Travel	<10%
Operating Voltage U_b	10-30VDC
Ripple U_{pp}	<10%
No-load Supply	<20mA max
Load Current Max	100mA
Time Delay Before Available	200ms
Weight	200g
Voltage Drop U_d	2V max.(100mA)
Output Type	PNP or NPN; Q/Qnot output Lo/Do selectable
Minimum Detectable Object/Spot Size	.7mm@1m-24mm@25m / 25mm@25m
Switching Frequency	800Hz
Tightening Torque	40Nm
Supply Electrical Protections	polarity reversal, transient
Output Electrical Protections	short circuit protection (autoreset)
Ambient Temperature T_a	-55--+80C
Temperature Drift	10% SR
Protection Degree (DIN 40 050)	IEC IP67
LED Indicators	Green (power supply) Yellow (on light state), (flashing light state), (off dark state)
Housing Material	PBT/PC